

Wireless Local Loop

By Homer Lloyd

**Manager of Strategic Marketing
Communication Products Division
Advanced Micro Devices**

Wireless Local Loop

- In developing nations, an enabling technology that will bring POTS to the masses
- In developed nations, a way for new providers to compete with the local exchange carriers for local service

Information Access - The Internet



Applications:

On-Line Shopping

Entertainment

Financial Services

Communications - email/voice

Telecommuting

Voice Communications

Wireless Technologies

Wireless Local Loop

Digital Cordless

Digital and Analog Cellular

PDA's

Wired Technologies

Copper POTS

ISDN

xDSL

Wireless Local Loop

- WLL field trials and installations are using many different technologies.
 - How large will the market be?
 - What system technologies will be important?
 - What semiconductor technologies are required in this market?

Emerging Wireless Local Loop Market Overview

WLL Market Conclusions

- Market is embryonic but growing rapidly
- Clear opportunity in emerging economies
- Enormous potential upside in developed economies
- More than one technology will evolve as leader:
 - Microcellular such as DECT and PHS
 - Macrocellular such as TDMA, CDMA, GSM

Worldwide Local Loop Demand

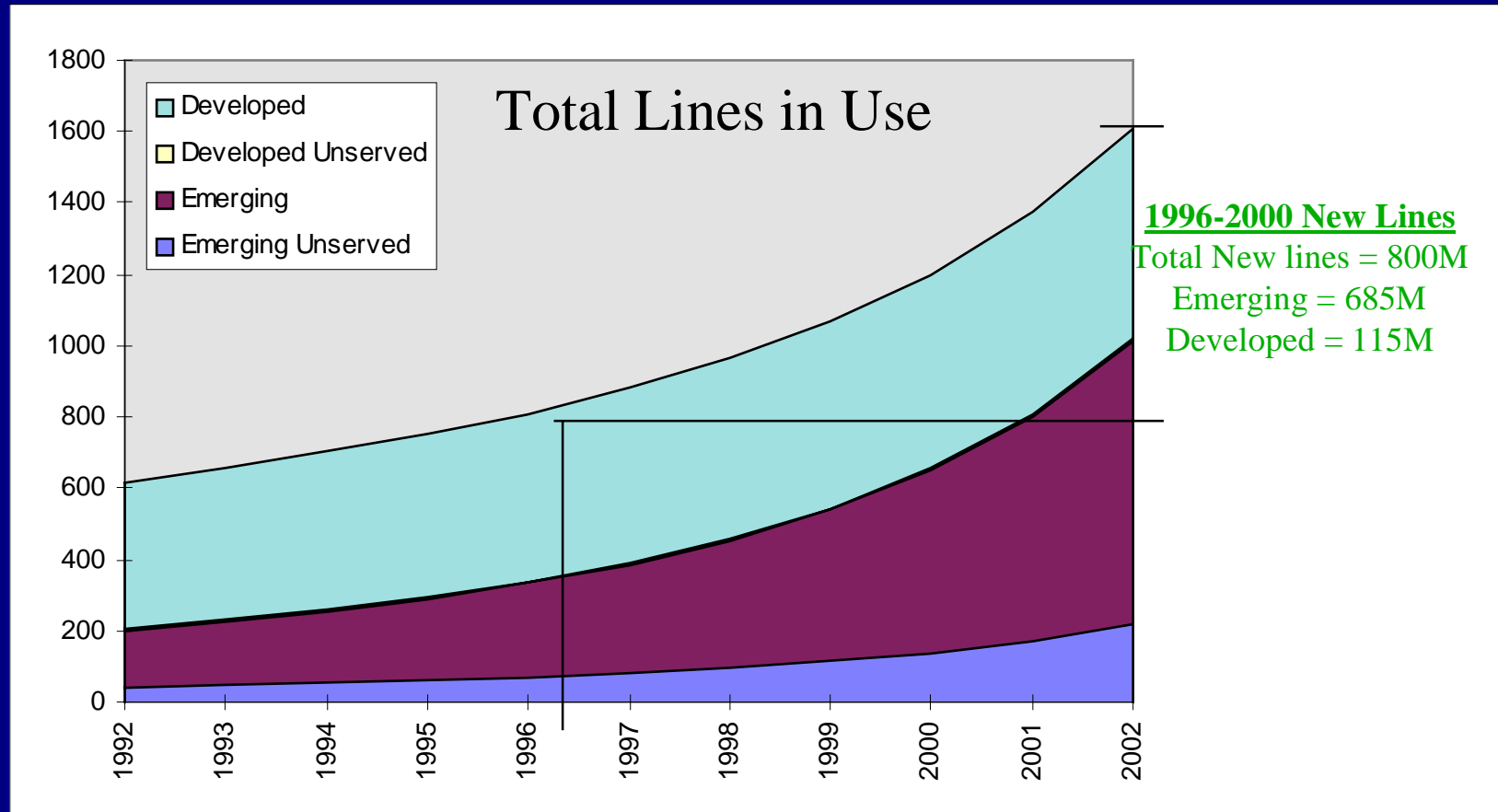

Source: ITU/AMD

Worldwide Local Loop - Assumptions

- Based on ITU historical data from 1992 - 1994
- Assumes growth rate for each country remains the same as 1992-1994
- Unserved demand is people on official waiting lists as of 1994 (43M) - source: ITU
- Unserved demand remains a constant percentage of installed lines

WLL Market Segmentation

- Market segments:
 - **Basic phone service in Emerging Economies**
 - » POTS and analog MODEM services
 - » Technologies: Analog/Digital cellular, DECT, PHS, Proprietary
 - **Wireless By-Pass in Developed Economies -**
 - » POTS, High Speed MODEM service, ISDN (2B+D), enhanced services, limited mobility
 - » Technologies: Digital cellular, proprietary, DECT, PHS

Worldwide Wireless Local Loop Subscribers

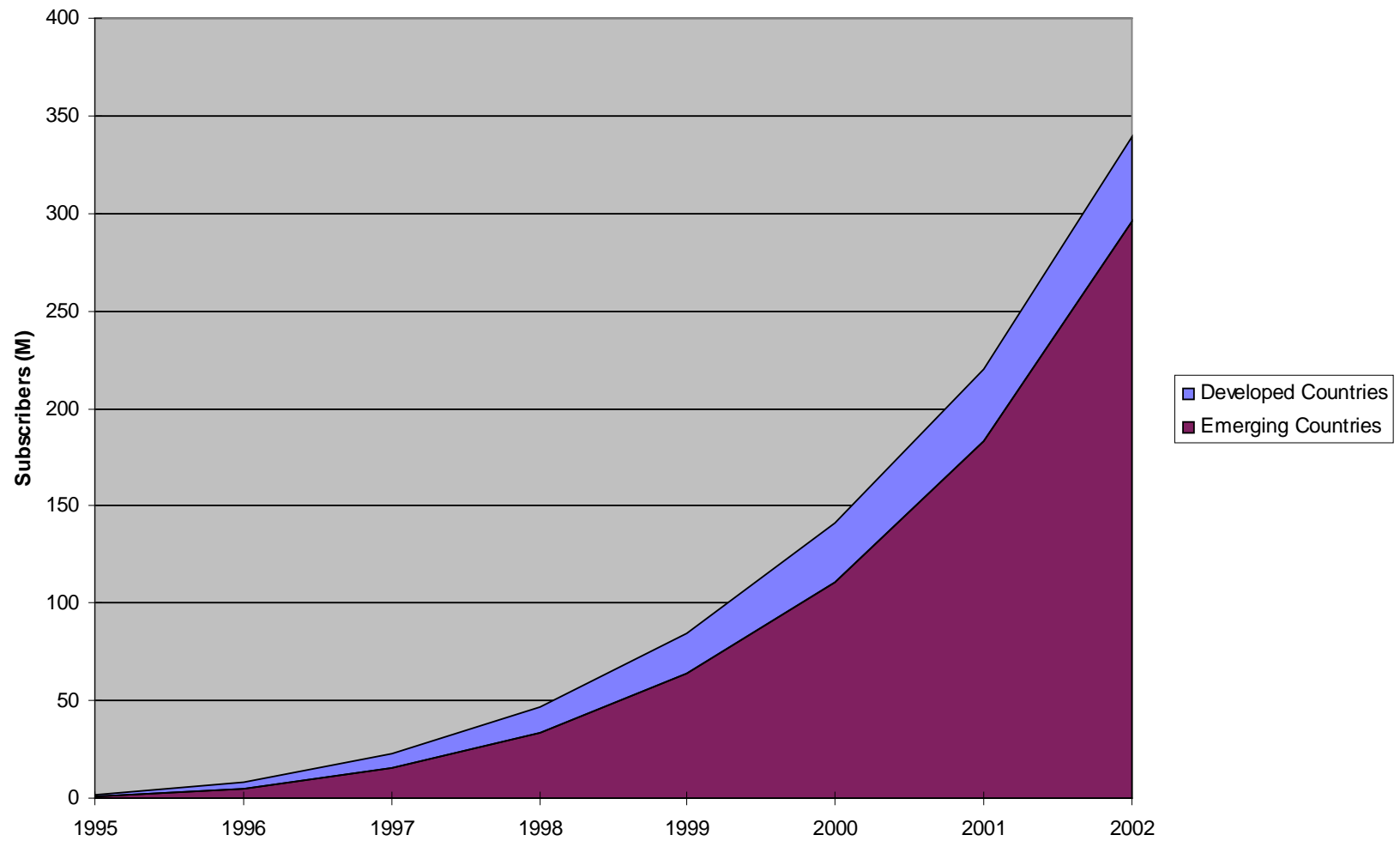

WLL Subscribers by Region

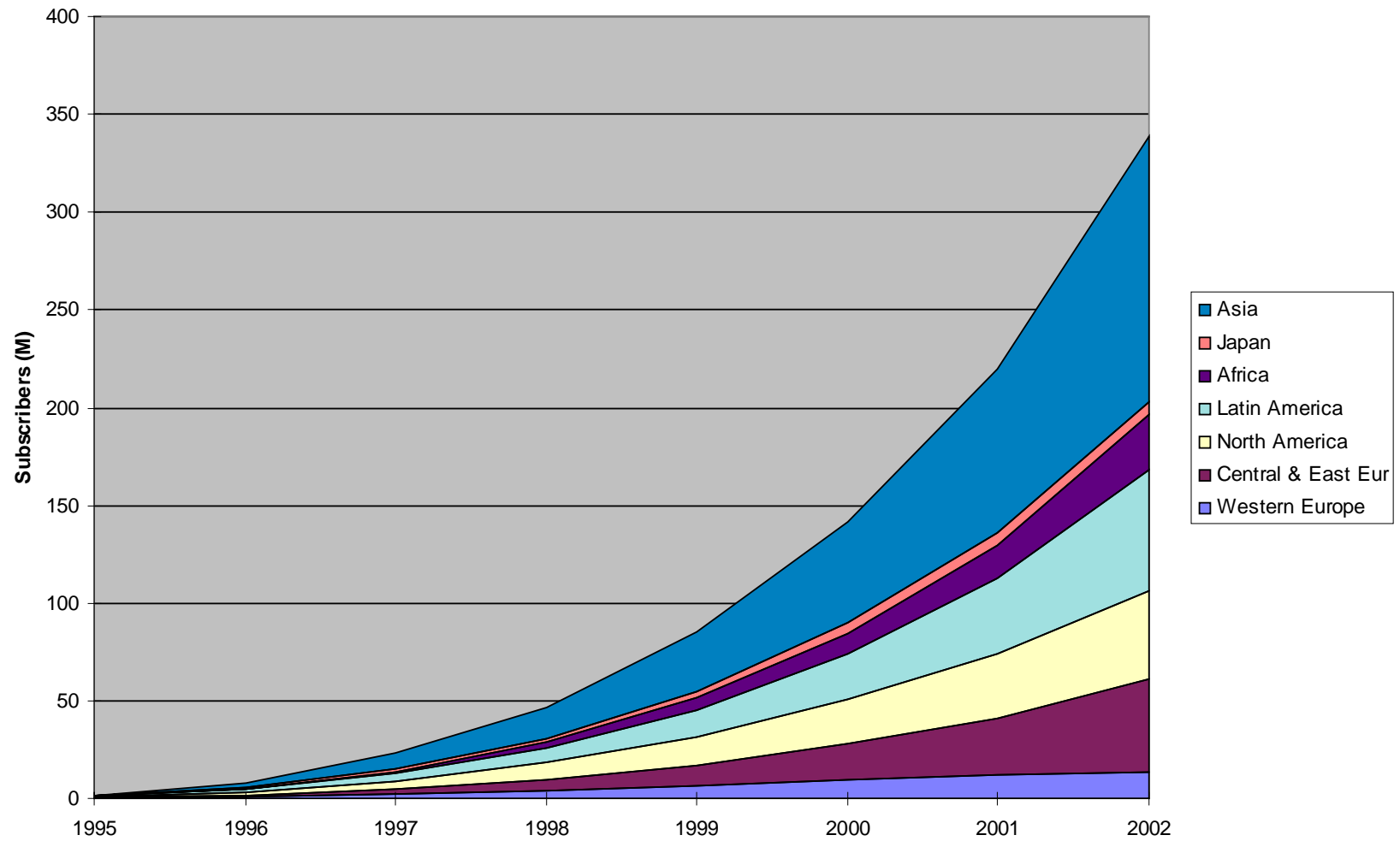

Why WLL? - Cost of the last mile

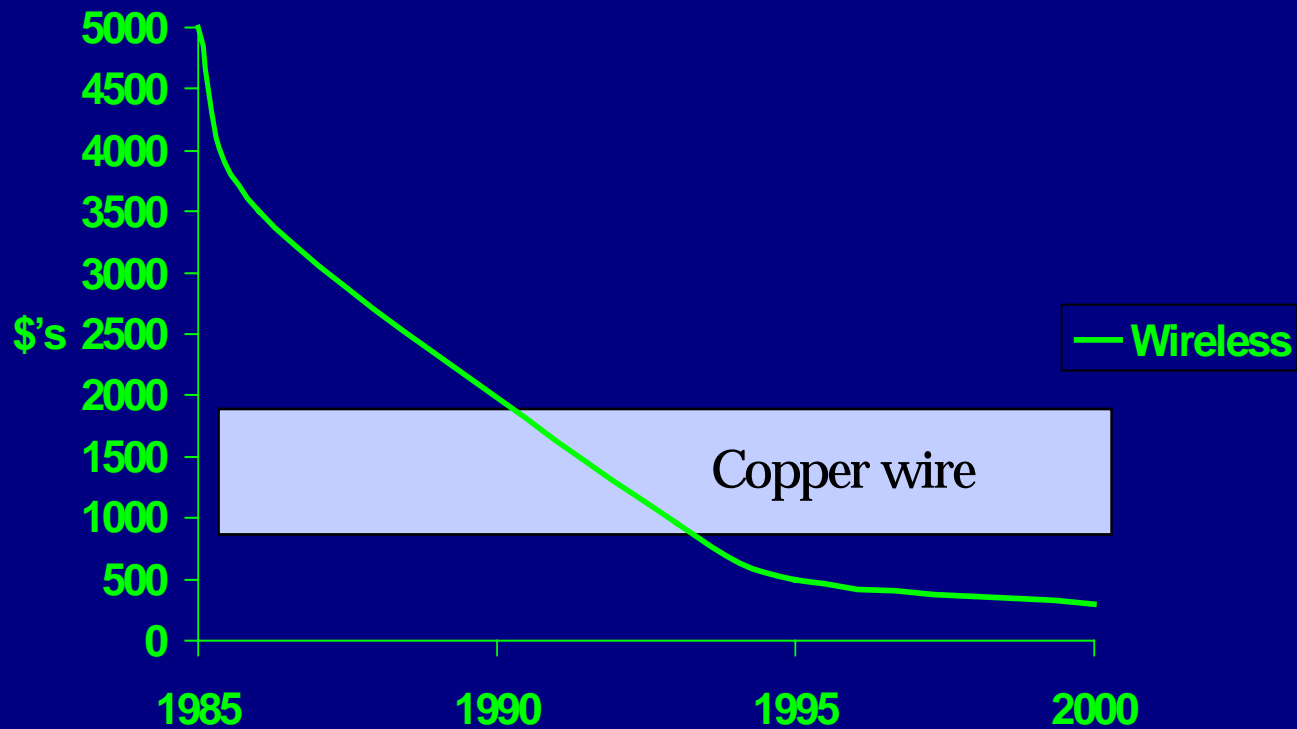

Source: Herschel Shosteck Associates

WLL vs. Copper

- Cost
 - Low Incremental investment cost
 - Much cheaper at lower subscriber densities
 - Quicker time to positive cash flow
- Ease and speed of service implementation
- Scalability and Versatility
- Maintenance and reliability

Market Segmentation - Requirements

	Developed (Bypass)	Emerging (Basic POTs)
Urban/ Sub-urban	<ul style="list-style-type: none"> Hi-speed data Enhanced services Limited mobility High traffic/subscriber densities 	<ul style="list-style-type: none"> POTS (voice quality) Modem data No (limited) mobility High traffic/subscriber densities
Rural	<ul style="list-style-type: none"> Same as above, but: Low subscriber densities Wide coverage 	<ul style="list-style-type: none"> Same as above, but: Low subscriber densities Wide coverage

Market Split - New Installations in the year 2000 (Total = 60MU)

	Developed	Emerging
Urban/ Sub-urban	9% + "Bypass upside" potential of 25%	51%
Rural	6% + "Bypass upside" potential of 10%	34%

Source: AMD, Shosteck

WLL Today

- Total installed = 825K, potential 18M
 - 14M of potential is in China
- Most installations today are in field trial
- Market leaders today are major Telecom companies like Alcatel, Ericsson, Lucent, Motorola, NEC, Nortel
- Many technologies used:
 - AMPS, TACS, CDMA, GSM, DECT, PHS

Comparison of WLL Systems

Comparison of WLL Systems

- Scenarios considered:
 - Developing world - Rural - Low penetration
 - Developing world - Rural - High Penetration
 - Developing world - Urban - Low penetration
 - Developing world - Urban - High Penetration
 - Developed world - Local loop Bypass

Computer Analysis Model

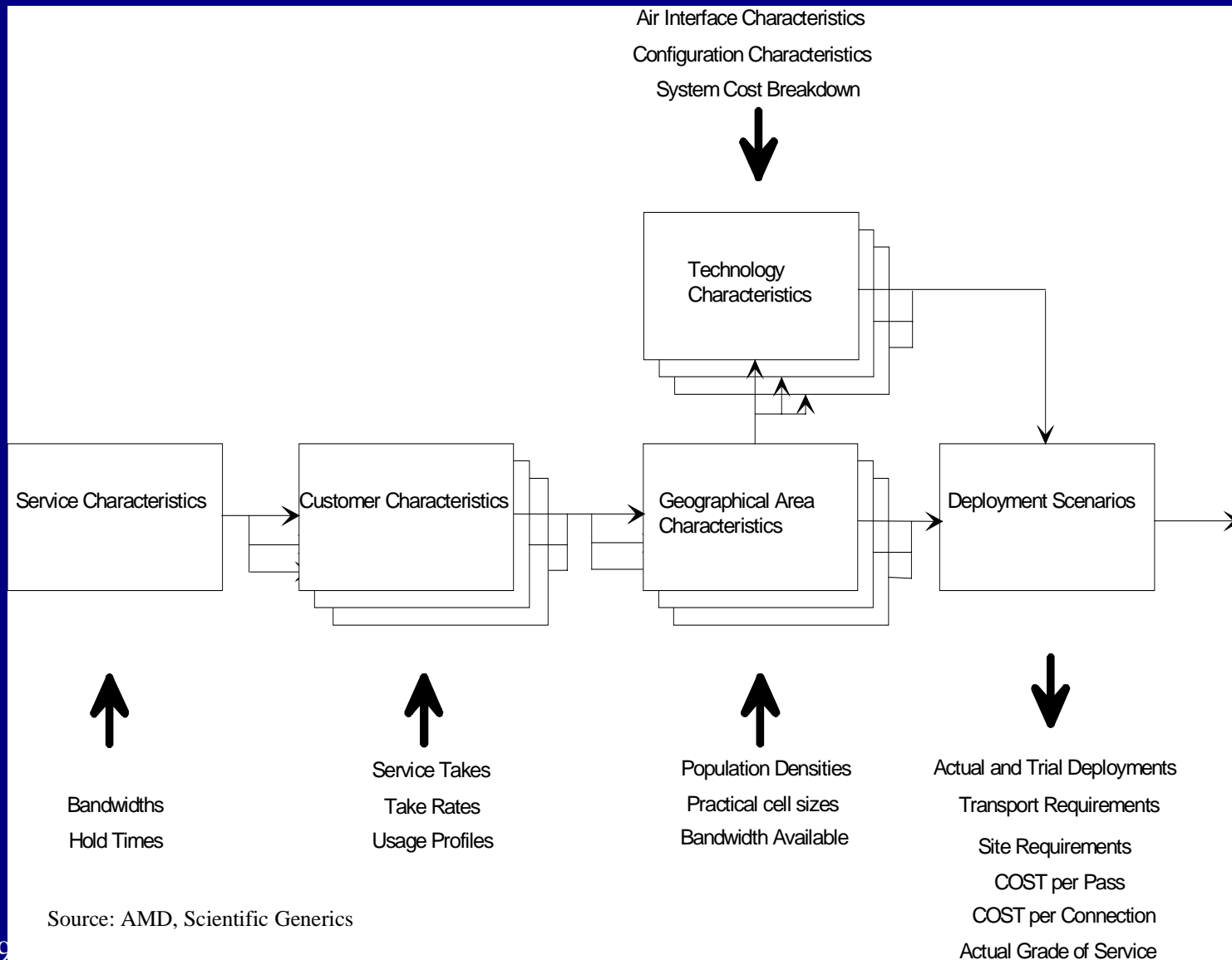

Source: AMD, Scientific Generics

Parameters Included in Model

- Modulation scheme (gives C/I requirement and bits per symbol)
- Transmitted symbol rate (or chip rate in CDMA systems)
- Channel symbol rates (for CDMA systems)
- Transmitted powers
- Antenna gains (vary with cell sectorization)
- Channels per carrier
- Carrier spacing
- Coding or equalization employed

Costs Included in Model

- Base station site and infrastructure costs
- Costs of radio equipment (varies with channels used per site)
- Costs of antenna equipment (varies with sectorization of base station)
- Costs of baseband processing and protocol conversion equipment
- Costs of backhaul from base station
- Costs of subscriber premises equipment
- Installation costs

Connection cost against population density

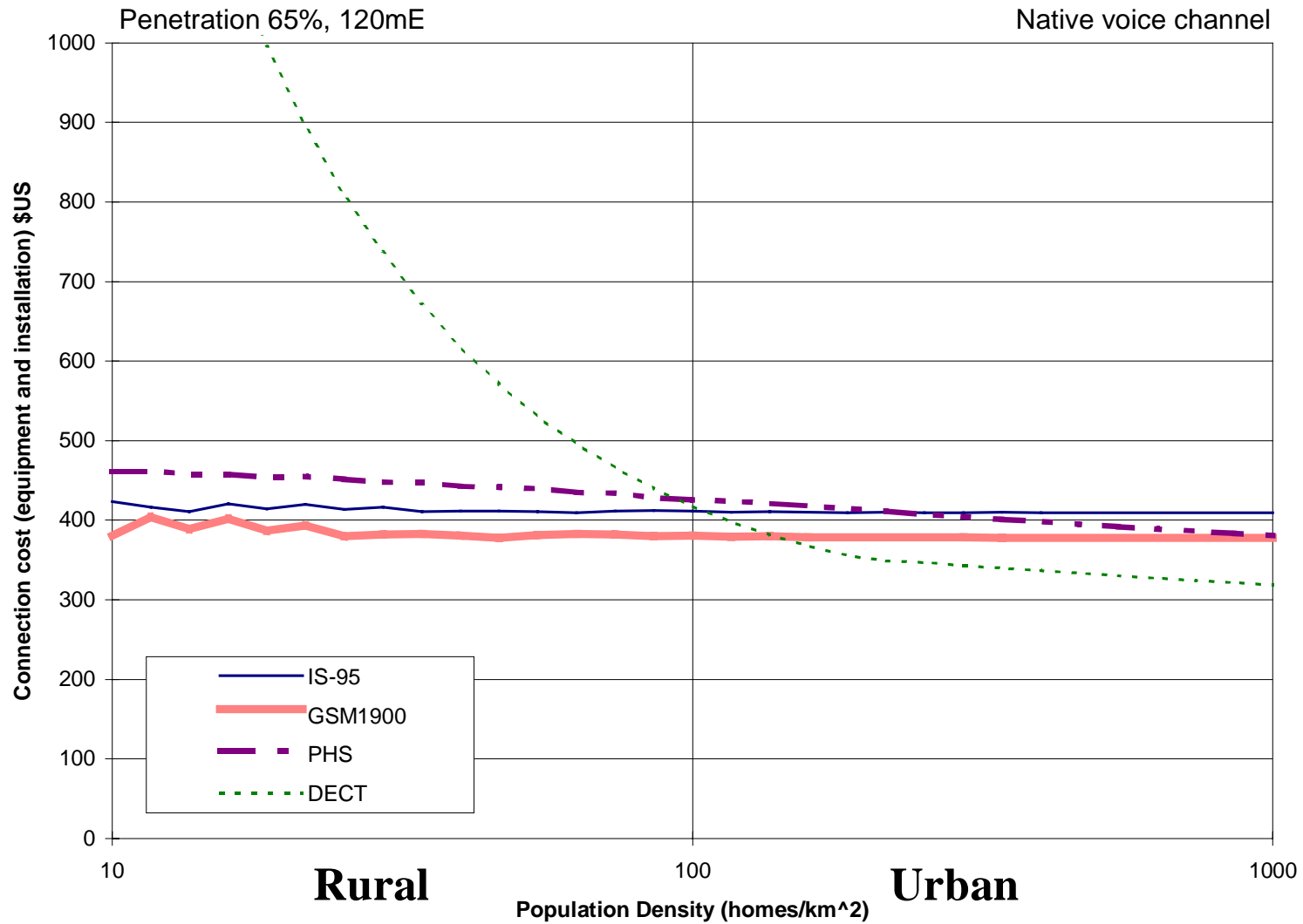

Source: AMD, Scientific Generics

Connection cost against population density

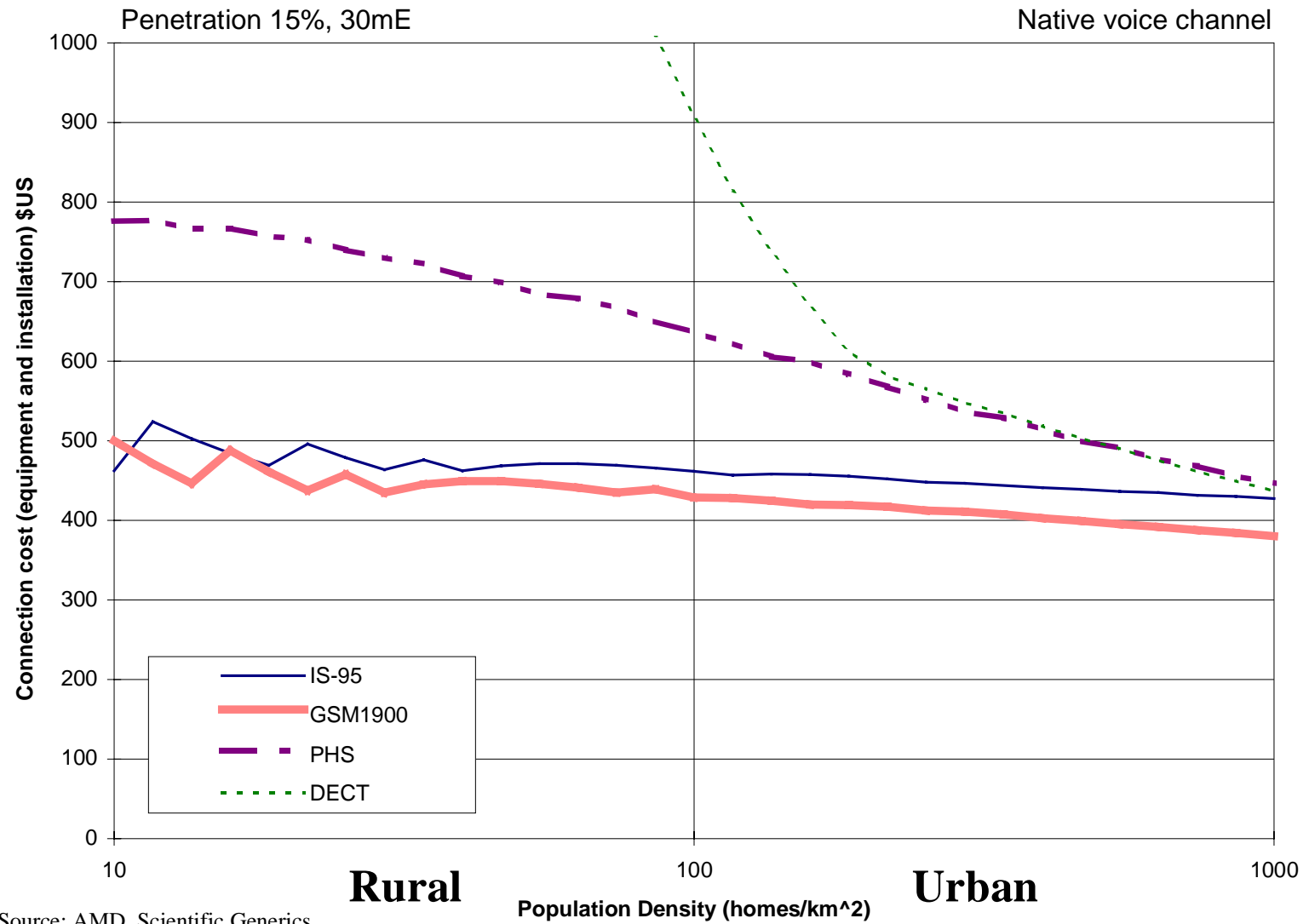

Notes to Analysis

- Cost depends on many factors including subscriber density, traffic, services, backhaul costs, equipment costs:
 - Analysis assumes backhaul costs similar for all systems, probably wrong for microcellular!
 - The costs are for installation only, does not include operation and maintenance or system and subscriber management software
 - Incremental investment costs must be considered

Market Segmentation - Technologies

	Developed	Emerging
Urban/ Sub-urban	Digital Cellular DECT PHS Proprietary	DECT PHS Digital Cellular Proprietary
Rural	Digital Cellular Proprietary	Digital Cellular Analog Cellular Proprietary

Semiconductors for WLL

WLL Digital Subscriber Terminal

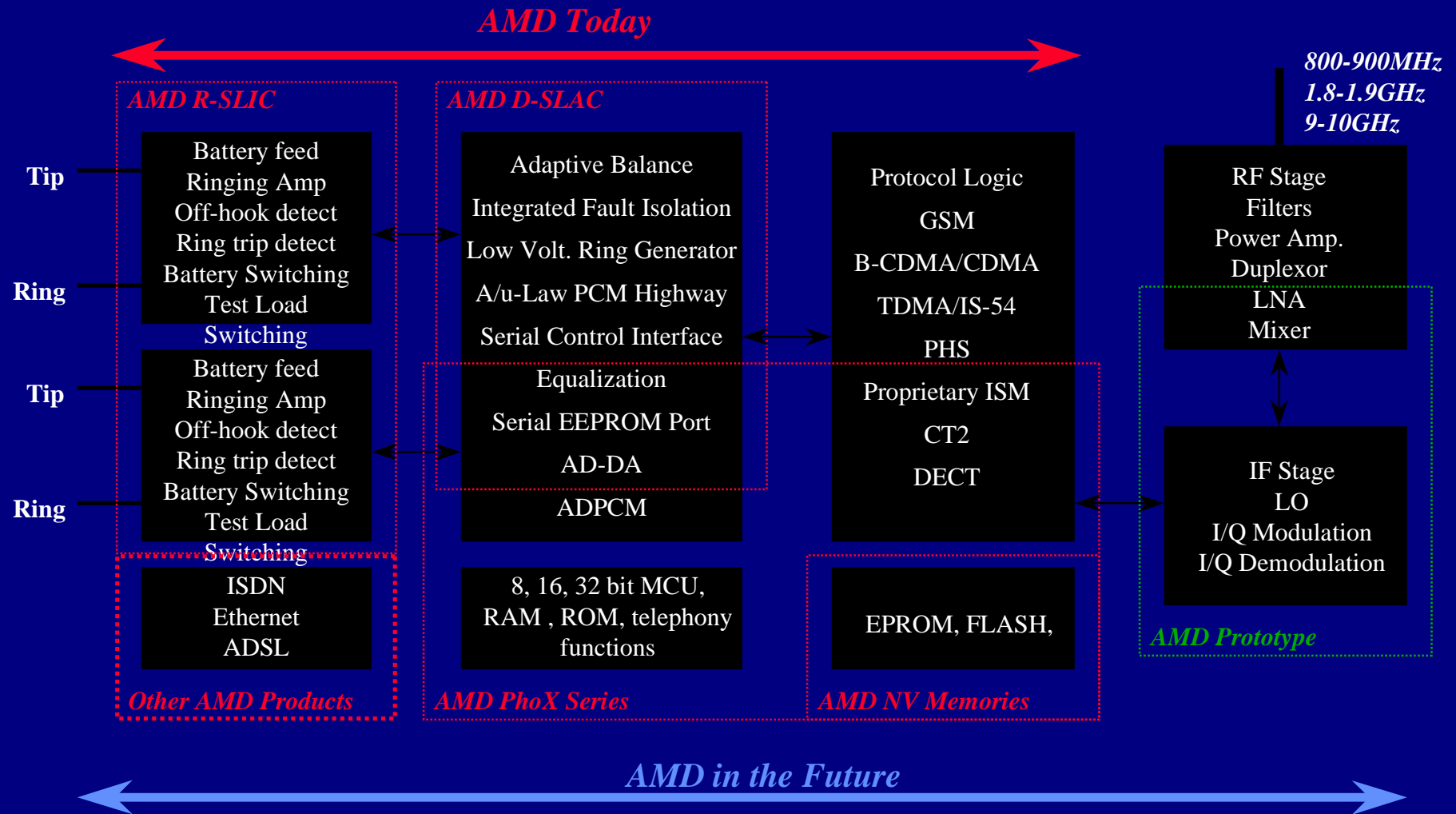

Semiconductor Requirements

- Must be low cost to enable mass deployment - integration
 - High integration means $< .5$ micron CMOS
- Antennae to Tip/Ring solutions require multitude of technologies
 - High voltage Tip/Ring interface
 - Dense, non-volatile memory
 - High speed CMOS
 - RF/IF requires low noise, high speed

Example of Integration: 79C412 PhoX

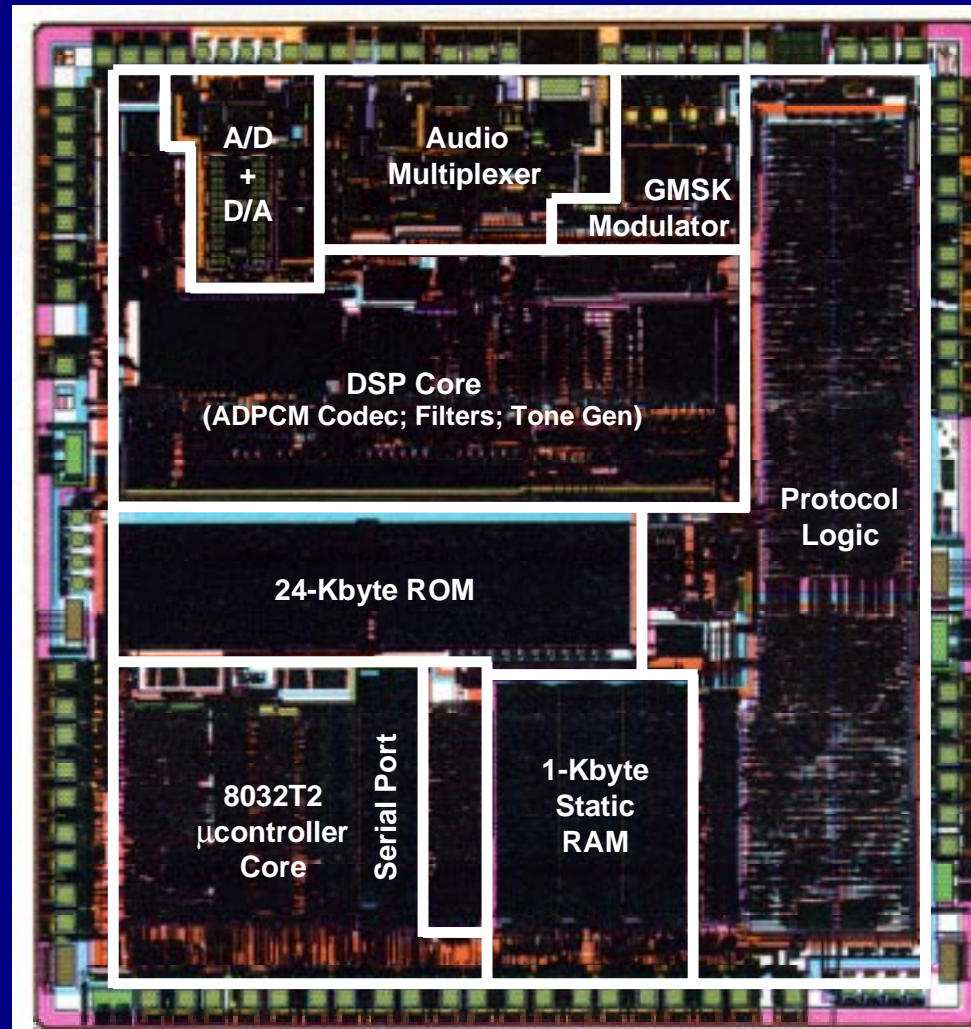

Technology Partitioning for Low Cost WLL Solutions

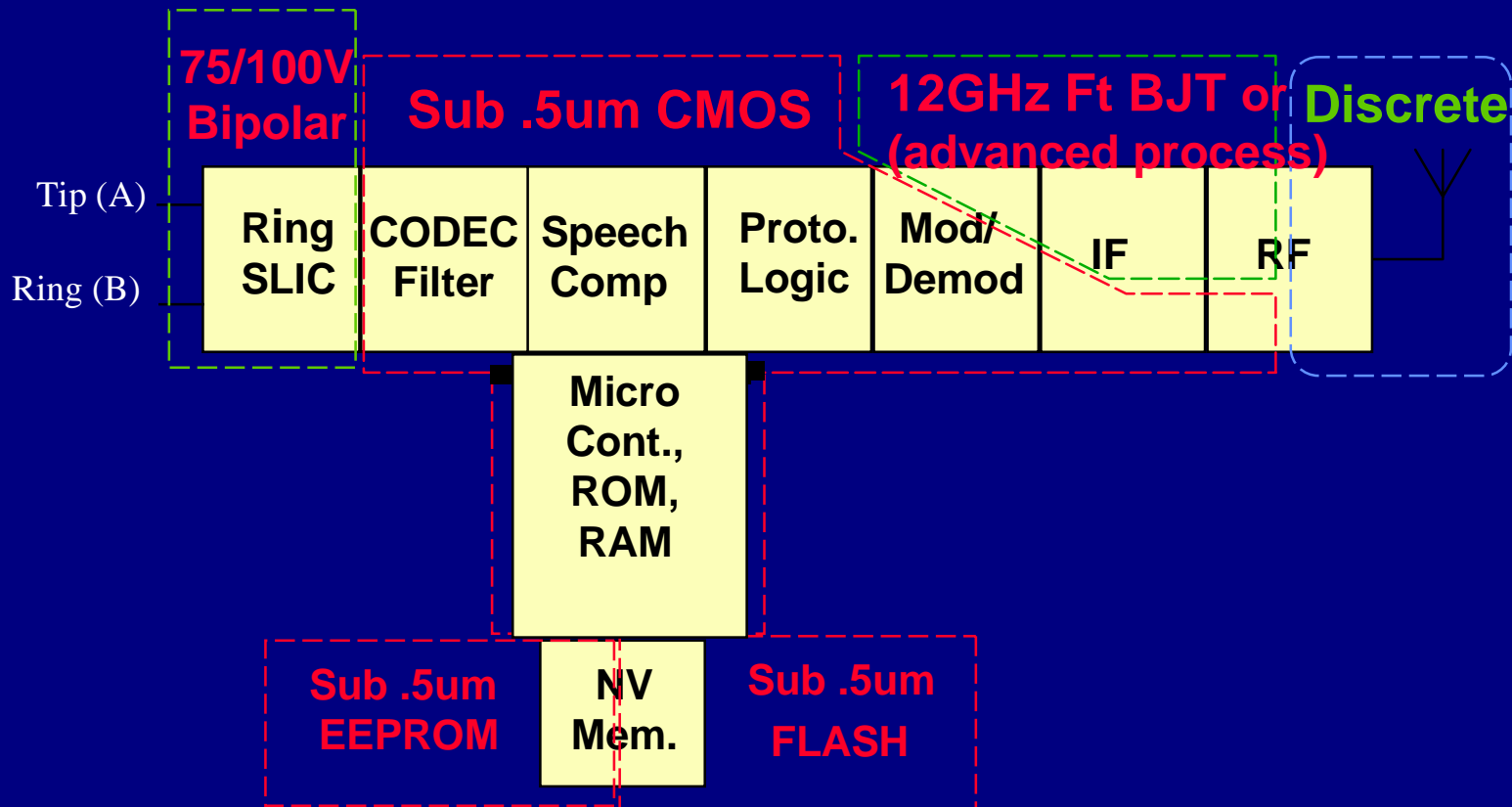

WLL Market Conclusions

- Market is embryonic but growing rapidly
- Clear opportunity in emerging economies
- Enormous potential upside in developed economies
- More than one technology will evolve as leader:
 - Microcellular such as DECT and PHS
 - Macrocellular such as TDMA, CDMA, GSM

WLL System Comparison Conclusion

- No one system is best for all applications:
 - Subscriber densities
 - Traffic conditions
 - Data support requirements
- Traditional wisdom that Microcellular (cordless) systems are better for urban areas and Macrocellular (cellular) systems are better for rural areas is not true for all conditions!

Conclusion

- How large will the market be?
 - Huge potential market, but -- requires the right cost and features
- Will standards evolve?
 - Yes, but more than one
- What semiconductor technologies are required in this market?
 - Antennae to Tip/Ring solutions require many technologies for lowest cost solution

AMD 

